

Inwertorowa spawarka SPARTUS[®] ProTIG

Semiautomatic welder SPARTUS[®] ProTIG



Instrukcja obsługi
User's manual



2000(W) AC/DC | 3000(W) DC



SPRZĘT SPAWALNICZY NA MIARĘ DZISIEJSZYCH POTRZEB

Dziękujemy Państwu za zakup naszego produktu!

Dokonałiście Państwo trafnego wyboru. Procesy spawania i cięcia plazmowego, prowadzone są w ciężkich warunkach, wystawiając sprzęt spawalniczy niejednokrotnie na ekstremalną próbę wytrzymałości. Tylko sprzęt wysokiej jakości może zapewnić odpowiednią niezawodność i wydajność przy prowadzeniu w/w procesów. I takie właśnie są produkty SPARTUS® – przede wszystkim niezawodne i trwałe, ale również wszechstronne. Wnikliwie w słuchujemy się w potrzeby klientów, stąd w naszej ofercie znajduje się tak bogaty asortyment. Ale dobry produkt to nie wszystko, równie ważna jest opieka serwisowa. I tutaj możemy Państwa zapewnić, że dzięki temu, że wybraliście Państwo produkty SPARTUS®, nie musicie się martwić o ewentualną opiekę serwisową. Nasz wykwalifikowany serwis jest zawsze do Waszej dyspozycji. Jeszcze raz dziękujemy za powierzone nam zaufanie i zapraszamy Was do zapoznania się z naszą ofertą na stronie www.spartus.pl lub bezpośrednio u lokalnego dystrybutora produktów SPARTUS®.

WELDING EQUIPMENT SUITABLE FOR TODAY'S NEEDS

Thank you for purchasing our product!

You have made a right choice. Plasma welding and welding processes are carried out in difficult conditions that expose welding equipment to extreme tests of its strength. Only high quality equipment can ensure required reliability and performance during realization of the above-mentioned processes. SPARTUS® products are characterized by precisely such features: they are primarily reliable and durable, but they are also versatile. We listen carefully to clients' needs. Therefore, our offer covers such a wide assortment of products. Thank you very much for your trust in our company. We would like to invite you to familiarize yourself with the remaining products and offer at www.spartus.info or directly at a local distributor of SPARTUS® products.



801 060 101

INFOLINIA TECHNICZNA

opcja dostępna tylko na terenie Polski
option available only in Poland

CZYNNY w dni robocze 8.00 – 16.00

• info@spartus.pl



TABLE OF CONTENTS

1.	SAFE USE – HAZARDS ASSOCIATED WITH ARC WELDING AND PLASMA CUTTING	2
1.1	General safety rules	2
1.2	Electric shock can kill	2
1.3	Welding arc radiation can be dangerous	3
1.4	Vapours and gases can be dangerous	3
1.5	Noise can be harmful	4
1.6	Fire or explosion hazard	5
1.7	Other hazards	6
1.8	Other informations	6
1.9	Symbols used in instructions	7
2.	ELECTROMAGNETIC FIELD (EMF)	7
3.	ELECTROMAGNETIC COMPATIBILITY (EMC)	7
3.1	General informations	7
3.2	Assesment of area	8
3.3	Methods of reducing emmissions	8
4.	CONFORMITY WITH STANDARDS	8
4.1	CE marking	8
4.2	Rating plate	8
5.	GENERAL DESCRIPTION	9
5.1	Purpose of use	9
6.	TECHNICAL SPECIFICATIONS	9
6.1	Operation, storage and transport	9
6.2	Technical parameters of device	10
7.	INSTALLATION AND USE	11
7.1	Proper cooling	11
7.2	Movement and handling	11
7.3	Description of construction	12
7.4	Connecting to power supply	13
7.5	Installation – TIG welding	13
7.6	Installation – MMA welding	15
7.7	Device control panel – using	15
7.8	Wireless remote control configuration	23
7.9	Pedal switch control	24
8.	MAINTENANCE	24
9.	ENVIRONMENTAL PROTECTION	25
10.	TROUBLESHOOTING	25



IMPORTANT!

Before using this product, read the instruction manual in its entirety, with understanding. Keep the instructions for quick reference to it if necessary. Pay special attention to safety instructions provided for your protection. In the event of any points of misunderstanding instructions, contact your supplier or supervisor.

1. SAFE USE – HAZARDS ASSOCIATED WITH ARC WELDING AND PLASMA CUTTING

Arc welding and plasma cutting are processes that can pose hazards for the operator and persons in his vicinity. The operator and his close surroundings are exposed, among others, to the risk of fire, explosion, electric shock, burning, as well as the risk of getting injured by moving parts of the device.

Once proper safety measures are provided, electric welding and plasma cutting are relatively safe processes. For this reason, it is crucial to strictly follow the valid OSH principles during welding operations.

The informations provided below do not release the operator from the obligation to follow the OSH rules that are binding in his plant/workplace.

1.1 GENERAL SAFETY RULES

Welding operators and persons working in the vicinity of the welding process should be made aware of the following hazards associated with arc welding. They should be made aware of protective measures as specified in relevant international and national standards and regulations.

1.1.1 Equipment condition and maintenance

- Check the technical condition of the device and accessories before starting to weld/plasma cutting. It is forbidden to use equipment that is unserviceable.
- Equipment damaged or defective should be immediately repaired or removed from service.

1.1.2 Operation and carrying

- Apply appropriate protective measures in the space around the zone, where welding operations are expected to be carried out.
- All equipment should be placed so that it does not present a hazard in passageways, on ladders or stairways, etc.
- Falling objects can cause injuries or kill. Protect device before accidentally falling.
- Welding equipment may be heavy (e.g. *wire*

feeder fitted with spool and harness). Care shall be taken during manual handling.

- To handle heavy elements, use hoists/trucks/transport equipment designed especially for this purpose. Make sure the weight of equipment to be handled does not exceed the admissible maximum lifting capacity of used hoist/truck/transport equipment.
- It is forbidden for unauthorized persons, especially children, to be in the vicinity of the device during its use.
- The device is not suitable for pipe defrosting.
- Device use non-compliant with its intended purpose is forbidden.

1.1.3 Training

- Only professionally trained and qualified personnel may install, operate, maintain and repair the device.
- For operators and their supervisors training is essential in: the safe use of the equipment; the processes; the emergency procedures.

1.2 ELECTRIC SHOCK CAN KILL



- Before starting to weld and during the welding process, the operator should insulate himself from the ground and the environment by means of dry and undamaged protective clothes. It is forbidden to work on wet ground.
- It is forbidden to touch SK sockets („+“ and/or „-“) when the device is in operation (*connected to a power supply source*).
- It is forbidden to touch live electric components of the device.

- Power supply must never be connected before the accessories of SK sockets/connectors are properly installed in the device.
- Use dry and undamaged welding gloves and protective clothing, in order to ensure proper insulation of the body. It is forbidden to touch with a bare hand any elements that are parts of an electric circuit.
- The operator must always make sure that there is a good electric connection of the return conductor to the element to be welded. The connection should be located as close to the welding zone as possible.
- Maintain the electrode grip, the welding torch, the chassis ground clamp, welding cables and the welding machine in proper technical condition that ensures safe operation. Damaged cable insulation should be replaced with new insulation.
- Never dip an electrode into water, to cool it down.
- When working above the floor level (at a height), use a safety harness to protect yourself against falling, in the case of potential electric shock.
- Exercise special caution, when using the device in small rooms or in rooms with elevated humidity levels.

1.3 WELDING ARC RADIATION CAN BE DANGEROUS

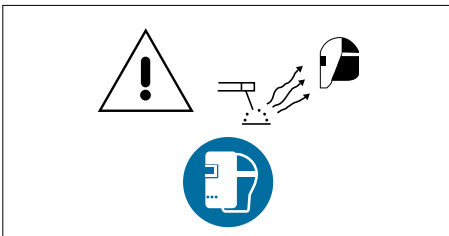

The arc generates:

- ultraviolet radiation (*can damage skin and eyes*);
- visible light (*can dazzle and impair vision*);
- infrared (*heat*) radiation (*can damage skin and eyes*).

Such radiation can be direct or reflected from surfaces such as bright metals and light coloured objects.

1.3.1 Eye and face protection

- Use welder's helmet/shield with an appropriate filter to protect you face and eyes against sparks and welding arc radiation.
- The shield / helmet should provide eye and face protection against injuries that may result in welding spatters.
- Welding helmet/shield should be made in accordance with applicable standards.

1.3.2 Body protection

- The body should be protected by suitable clothing in accordance with applicable standards.
- Use appropriate protective clothing made of durable and fire-resistant material, to ensure proper skin protection.
- The use of neck protection can be necessary against reflected radiation.

1.3.3 Protection of persons in the vicinity of an arc

- Protect the remaining personnel present in the vicinity of welding works against negative impact of arc radiation and welding splatters. Warn them about the hazard resulting from exposure to the welding arc. In the vicinity of an arc, non-reflective curtains or screens should be used to isolate persons from the arc radiation. A warning, e.g. a symbol for eye protection, should refer to the hazard of arc optical radiation. Welder's assistants should also wear appropriate protective clothing.

1.4 VAPOURS AND GASES CAN BE DANGEROUS



Arc welding and allied processes produce welding fume which may pollute the atmosphere surrounding the work. Welding fume is a varying mixture of airborne gases and fine particles which, if inhaled or swallowed, constitute a health hazard.

The degree of risk is depend on:

- the composition of the fume;
- the concentration of the fume;
- the duration of exposure.

A systematic approach to the assessment of exposure is necessary, taking into account the particular circumstances of the operator and the ancillary worker who can be exposed.

Welding fume may be controlled by a wide range of measures, e.g. process modifications, engineering controls, methods of work, personal protection and administrative action.

First it is necessary to consider whether exposure can be prevented by eliminating the generation of welding fume altogether. Where this cannot be done, measures for reducing the quantity of welding fume generated should be investigated, after which the control of welding fume at source should be considered. The use of respiratory equipment should not be contemplated until all other possibilities have been eliminated. Normally, respiratory protective equipment should be used only as an interim measure. However, there cannot be a situation in which, in addition to ventilation, the use of personal protection is necessary.

1.4.1 VAPOURS AND GASES. ADDITIONAL PRECAUTIONS

- Welding operations can involve generation of vapours and gases that are hazardous to health. Inhaling the vapours should be avoided. Keep your head away from vapours during welding operations. Ensure proper ventilation and/or mechanical welding exhaust draught to keep vapours and gases away from the breathing zone.
- When welding is carried out in a confined space, operators should only be permitted to weld when other persons, who have been instructed and who are able to react

in case of an emergency, are in the immediate vicinity.

- In closed rooms or in certain circumstances during outdoor operations, it may be required to use individual equipment for the protection of the welder's airways, e.g. a respirator. Additional safety measures are also required when galvanized steel is welded.
- Welding operations must not be performed in the vicinity of chlorinated hydrocarbons generated during degreasing, cleaning or spraying. Heat and radiation generated by the arc may enter into a reaction with vapours of solvents, which may lead to the formation of phosgene – a highly toxic gas.
- The shielding gas used during arc welding may force the air out of a room. This may lead to a health hazard or even death. Proper ventilation, especially in closed rooms, should always be provided, to ensure appropriate amount of air that is indispensable for safe breathing.

1.5 NOISE CAN BE HARMFUL



In the welding environment, damaging levels of noise can exist. Continued exposure to a high noise level on the unprotected ear is injurious. The noise levels should be reduced to the lowest practicable level.

High levels may be tolerated for very short periods by wearing adequate ear protection in accordance with the national or local regulation. In case of doubt, checks by an expert should be made to establish noise levels in any particular environment, and, if these are in excess of the prescribed limit, one of the following alternatives may apply:

- a) insulation of the noise source as far as possible, e.g. by fitting silencers or sound proof enclosures,
- b) insulation of the operator from the noise

- source,
- c) effective maintenance of sound protection devices,
- d) indication as „ear protection areas“ where applicable,
- e) restriction of entry to these „ear protection areas“ to authorized persons,
- f) protect your hearing with appropriate personal protection measures, e.g. earplugs or hearing protectors.

1.6 FIRE OR EXPLOSION HAZARD

Arc welding and allied processes can cause fire and explosions. Precautions should be taken to prevent these hazards.

1.6.1 Fire hazard



- Before setting to perform welding operations, ensure that elements involving fire hazard are removed from the zone where welding operations will take place. If it is impossible, protect all flammable elements against the impact of sparks. Remember that sparks and hot metal may penetrate through small cracks and openings into the adjacent area.
- Avoid welding in the vicinity of hydraulic conduits.
- The welding arc throws sparks and splatters out. Welders should wear clean and dry protective clothing (*staining with oil should be avoided in particular*) such as welding gloves, welder's apron, welder's trousers, welder's boots, protective hood/cap, etc.
- When welding operations are not carried out, make sure that no part of the electrode comes into contact with the workpiece or protective earthing. Accidental contact may lead to overheating and create a fire hazard.
- The fire extinguisher should be ready for use and located in an easily accessible place.

- The surroundings of the work should be observed for an adequate period after its termination.
- „Hot spots“ and immediate surroundings should be observed until their temperature has dropped to normal.

1.6.2 Explosion hazard

It is forbidden to heat up, cut or weld tanks, barrels or containers that contained toxic or flammable materials. For there is an explosion hazard, even if the containers have been emptied and cleaned.

1.6.3 Use of cylinders with shielding gas

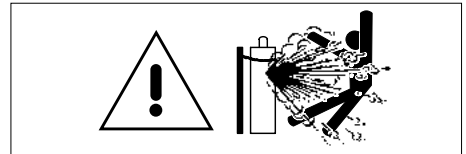

In case compressed gases are used in the work place, apply special safety measures to prevent dangerous situations.

- Use gas cylinders with appropriate shielding gas, foreseen for a particular process. Additional equipment (pressure regulator, hoses, connectors) should be in good technical condition. A gas cylinder and accessories should have the required valid attestations and approvals for use.
- Gas cylinders should always be stored in vertical position, fixed to an undercarriage or permanent support.
- Gas cylinders should be placed far away from areas, where they could be exposed to the risk of being overturned or suffering physical damage.
- Ensure gas cylinders are at a safe distance from places where electric welding or cutting operations are to be performed, away from other sources of heat, sparks or flames.
- Care shall be taken to prevent gas cylinders in the vicinity of the workpiece becoming part of the welding circuit.
- Never allow the electrode, electrode holder or any other live electric part to get in contact with the gas cylinder.

- Keep your face and head away from the cylinder valve socket when the valve is being opened.
- Special valve shield should always be installed during cylinder transportation or when the cylinder is not used.

1.7 OTHER HAZARDS

Arc welding and allied processes carrying other hazards not listed before.

1.7.1 Burns

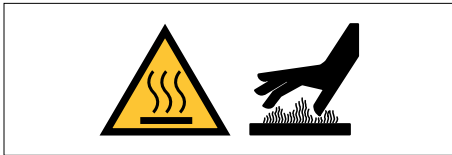

- Never touch hot parts with bare hands.
- Before handling an element, wait until it cools down.
- Use appropriate tools to grip and handle hot elements and wear special welding gloves and clothing that protects against burns.

1.7.2 Plasma arc is dangerous

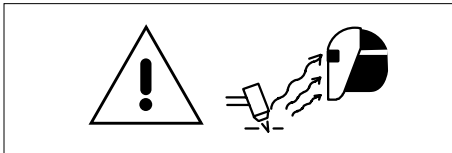

Highly concentrated plasma arc poses a hazard for health and life. It is forbidden to aim plasma arc at people.

1.7.3 Welding wire can cause injuries



Accidental pressing of the button on the welding torch can cause welding wire to advance in an uncontrolled manner. The welding wire tip may be sharp.

Never aim the burner tip of the welding torch at your face, eyes or other people.

1.7.4 Moving elements can be dangerous

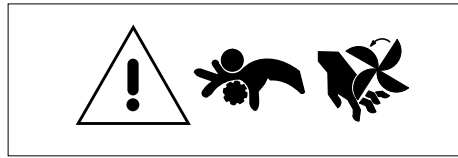

All protective elements and device housing should be in place and in good technical condition. Keep your hands, hair, clothes and tools away from gear wheels, fans and other moving parts during their operation.

Do not bring your hands close to fan motors. It is forbidden to stop a fan by pressing its axis.

1.7.5 HF – high frequency ignition may cause interference



As welding by the TIG method or plasma cutting involves high frequency ignition, it can interfere with mobile phones, radio equipment, TV equipment or improperly protected computers and industrial robots, which leads to total disabling of such devices.

1.8 OTHER INFORMATIONS

When performing welding work, you must apply equally to the health and safety requirements contained in the current normative acts, applicable in your country.

**WARNING!**

The maximum voltage of 15kV. Accidental pressing of the microswitch results in unintentional arc ignition. Never bring a bare hand close to the electrode, when the device is connected to a power source.

1.9 SYMBOLS USED IN INSTRUCTIONS

We use this symbol to pay your attention about important information.

2. ELECTROMAGNETIC FIELDS (EMF)

Electric current flowing through any conductor causes localized electric and magnetic fields (EMF). All welders should use the following procedures in order to minimize the risk associated with exposure to EMF from the welding circuit:

- Route the welding cables together – secure them with tape when possible.
- Place your torso and head as far away as possible from the welding circuit
- Never coil welding cables around your body.
- Do not place your body between welding cables. Keep both welding cables on the same side of your body.
- Connect the return cable to the workpiece as close as possible to the area being welded.
- It is forbidden to sit or lean on power source while working.
- Do not weld whilst carrying the welding power source or wire feeder.

**WARNING!**

The electromagnetic field (EMF) generated during welding (and allied processes) may interfere with the operation of implanted medical devices for example: cardiac pacemakers. Persons with implanted medical devices such as cardiac pacemakers are obliged to consult a doctor before starting to weld/plasma cutting and to exercise special caution during work. It is forbidden for such persons to be present in the vicinity of the place where welding/plasma cutting processes are realized without previous consultation of a doctor.

3. ELECTROMAGNETIC COMPATIBILITY (EMC)**WARNING!**

This Class A equipment is not intended for use in residential locations where the electrical power is provided by the public low-voltage supply system. There can be potential difficulties in ensuring electromagnetic compatibility in those locations due to conducted as well radiated radio-frequency disturbances.

3.1 GENERAL INFORMATIONS

The user is responsible for installing and using the arc welding equipment according to the manufacturer's instructions. If electromagnetic disturbances are detected, then it shall be the responsibility of the user of the arc welding equipment to resolve the situation with the technical assistance of the manufacturer. In some cases this remedial action may be as simple as earthing the welding circuit. In other cases, it could involve constructing an electromagnetic screen enclosing the welding power source and the work complete with associated input filters. In all cases electromagnetic disturbances shall be reduced to the point where they are no longer troublesome.

! *Welding and plasma cutting processes may emit additional interferences. User is responsibility for the interferences caused by welding and plasma cutting.*

3.2 ASSESSMENT OF AREA

Before installing arc welding equipment, the user shall make an assessment of potential electromagnetic interferences in the surrounding area. The following shall be taken into account:

- a) other supply cables, control cables, signaling and telephone cables, above, below and adjacent to the arc welding equipment,
- b) radio and television transmitters and receivers,
- c) computer and other control equipment,
- d) safety critical equipment, for example guarding of industrial equipment,
- e) the health of the people around, for example the use of pacemakers and hearing aids,
- f) equipment used for calibration or measurement,
- g) the immunity of other equipment in the environment. The user shall ensure that other equipment being used in the environment is compatible. This may require additional protection measures.
- h) the time of day that welding or other activities are to be carried out.

The size of the surrounding area to be considered will depend on the structure of the building and other activities that are taking place. The surrounding area may extend beyond the boundaries of the premises.

3.3 METHODS OF REDUCING EMISSIONS

Methods of reducing electromagnetic interference are listed in detail in the standard EN 60974-9 – „Arc welding equipment – Part 9: Installation and use“.

4. CONFORMITY WITH STANDARDS

The SPARTUS® ProTIG 2000 AC/DC and 3000 DC is in conformity with the relevant Union harmonization legislation:

LVD 2014/35/UE

Low Voltage Directive

harmonized standards:

EN 60974-1:2021

Arc Welding Equipment – Part 1: Welding Power Sources

4.1 CE MARKING

CE marking is placed on the nameplate of device and/or on the front panel of device.



4.2 RATING PLATE

Rating plate and serial number are located on the device case.

5. GENERAL DESCRIPTION

SPARTUS® ProTIG 2000 AC/DC and 3000 DC

These are a modern inverter welders that allow TIG and MMA welding with current up to 200A for ProTIG 2000 AC/DC and 320A for ProTIG 3000 DC. Machines are powered from a 400V three-phase network – ProTIG 3000 DC and single-phase 230V – ProTIG 2000 AC/DC.

The high-class sources allow you to set the following parameters in the TIG method:

- upslope/downslope time,
- for TIG Puls: puls current, base current, pulse frequency, pulse width,
- mode selection 2T/4T / MultiSPOT/SingleSPOT,
- Pre Gas, Post Gas,
- 10 memory channels
- intelligent protection against device overheating

in the MMA method:

- welding current,
- Arc Force, Hot Start.

All settings on the front panel can be adjusted continuously and steplessly. This not only facilitates control, but also allows you to precisely set and adjust advanced parameters.

Thanks to the TIG Puls function, the device is perfect for welding very thin sheets made of stainless steel, carbon steel, alloyed steel, titanium, magnesium, cuprum and aluminum.

SPARTUS® ProTIG 2000 AC/DC and 3000 DC have 10 memory channels. The user can easily save and recall the most used settings.

Modern design, LCD function panel and the possibility of wireless control in combination with high-class components make the SPARTUS® ProTIG 2000 AC/DC and 3000 DC stand out on the market.

SPARTUS® ProTIG 2000 AC/DC i 3000 DC are equipped with an integrated liquid cooler, which ensures efficient cooling of the gun during welding with high currents. The whole is placed on a transport cart with space for a shielding gas cylinder.

The professional device of the SPARTUS® Pro line is perfect suited to the production sector and industry. It is applied to pipe installment, mould mend, petrochemical, architecture decoration, car repair, bicycle, handicraft and common manufacture.

5.1 PURPOSE OF USE

SPARTUS® ProTIG 2000 AC/DC and 3000 DC welding machine is designed for :

- Tungsten Inert Gas welding (TIG),
- Manual Metal Arc welding (MMA).

6. TECHNICAL SPECIFICATIONS

6.1 OPERATION, STORAGE AND TRANSPORT

Conditions during operation, storage and transport

Range of ambient air temperature during operation	-10°C to +40°C
Relative humidity of the air	up to 50% at +40°C up to 90% at +20°C

Ambient air	free from abnormal amounts of dust, acids, corrosive substances etc. other than those generated by the welding process
Base of the welding power source inclined	up to 10°
Range of ambient air temperature during storage and transport	-20°C to +55°C

**Duty cycle (def.)**

Duty cycle is the time during which You can weld or cut at a certain load without causing overload. It is expressed in percent for period of complete cycle which equals 10 minutes. For example: 60% duty cycle means that for 6 minutes device can operate at given load, after that required 4 minutes time break (no-load operation). Duty cycle is given to ambient temperature of 40°C.

**Protection against overheating (def.)**

Security system from overheating will turn on when the welder is over-heat (possibility of welding is turned off, abnormal indicator on front panel lights up). In such a situation, You should not turning off the unit immediately. Wait some time until fan cools the unit. Time to return to the state from overheating can take up to approx. 15 minutes.



The device has a degree of protection IP23S. Which means that it is intended to be used in closed and covered areas and suitable for use outdoors. However it is not designed to be used outdoor during precipitation if it is not covered.

6.2 TECHNICAL PARAMETERS OF DEVICE

SPARTUS® ProTIG

	2000 AC/DC	3000 DC
Input	~1 x 230V ±10% 50/60 Hz	~3 x 400V ±10% 50/60 Hz
Welding Current AC/DC [A]	10 – 200 / 3 – 200	DC: 5 – 320
Duty cycle [%]	60	

TIG PARAMETERS

Start Amps, End Amps	✓	
Gas pre flow [s]	0.1 – 2	
Up slope/Down slope [s]	0 – 10	
Gas post flow [s]	0 – 10	
PULSE mode	✓	
Pulse / Base Amps [A]	DC: 3 – 200 AC: 10 – 200	5 – 320
Pulse Width [%]	5 – 95	
Pulse frequency [Hz]	0.5 – 999	
AC frequency [Hz]	50 – 250	-
AC Wave Forms	square, sinusoidal, triangular	-
AC balance	10 – 99	-
No-load voltage [V]	60	73
2T/4T control	✓	
SPOT	MultiSPOT / SingleSPOT	

Arc ignition	LIFT / HF
Output remote control	✓

MMA PARAMETERS

MMA welding mode	✓
Welding current MMA [A]	10 – 200 10 – 320
Arc Force range [A]	0 – 10
Hot Start range [A]	0 – 10
No-load voltage [V]	10 10.5

OTHER

Current consumption [A]	AC: TIG 20.1 / MMA 28.7 DC: TIG 20.8 / MMA 30.2	TIG 18.4 / MMA 24.4
Power factor (cosφ)	0.99	0.7
Insulation class	H	
Protection class	IP23	
Weight [kg]	13.2	17.5
Dimensions [mm]	550 × 190 × 360	560 × 200 × 380

7. INSTALLATION AND USE



WARNING!

SPARTUS® ProTIG machines are intended for professional and industrial applications. Installation and use of the device may only be carried out appropriately trained professionals.

*It is **forbidden** to grinding and/or carrying out other locksmith works or mechanical working of metal in the vicinity of the ventilation opening of unit.*



Qualified person (def.)

A person who has gained the relevant technical education, training took place and / or gained experience to perceive the risk and avoid hazards during use of the product (IEC 60204-1).

7.1 PROPER COOLING

The unit should be placed stable on a dry and flat surface. Avoid too much slope and slippery surfaces. Check regularly that the vents (inlet, outlet) are not covered. The minimum distance between the welder vents and walls should be 50cm.

7.2 MOVEMENT AND HANDLING

Please take special care when moving the welding machine. It should be moved by using of specially designed transport handles (version without welding cart).

Version with welding cart. The source is available on a specially constructed transport trolley (platform), equipped with road wheels and a transport handle.

If transport handle (device/trolley) or trolley wheels are damaged, then it needs to be repaired at an authorized service center.

7.3 DESCRIPTION OF THE SOURCE AND COOLER CONSTRUCTION

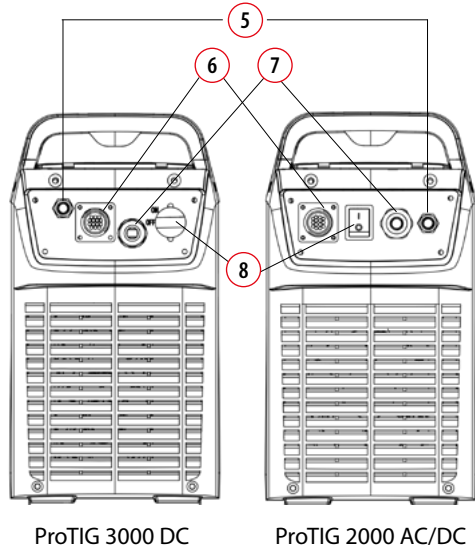
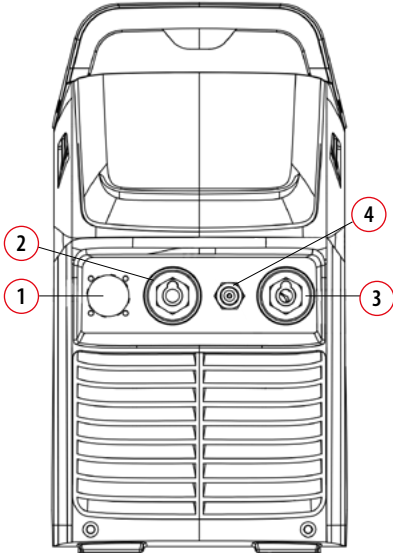

ProTIG 3000 DC

ProTIG 2000 AC/DC

- 1 Control plug socket (TIG)
- 2 SK socket „-“
- 3 SK socket „+“
- 4 Gas connector TIG

- 5 Shield gas input joint
- 6 Water cooler remote connection socket
- 7 Power source input
- 8 ON/OFF switch

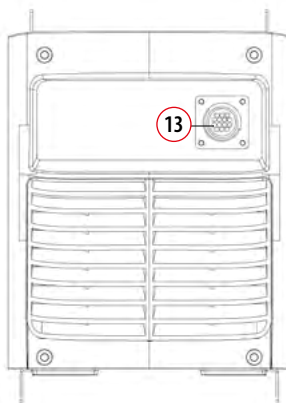
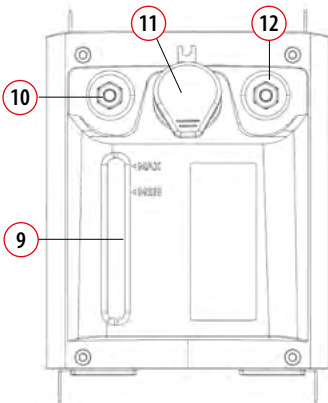

- 9 Water level calibration
- 10 Water outlet for TIG
- 11 Coolant refill inlet
- 12 Backwater inlet for TIG
- 13 The water cooling control connector

7.4 CONNECTING TO POWER SUPPLY

Requirements for power network parameters (voltage, permissible range of mains voltage fluctuations etc.) are given in the table with technical parameters of device and on the rating plate of welding machine.

Before connecting the unit to the power source:

- Check whether the parameters comply with the requirements for unit.
- Check: mechanical condition of the power cord and plug. The connection status of the power cord with plug and unit (loose not allowed). If the power cord or plug is damaged or loose connection is between them, it is forbidden to connect the welder until fault has been rectified.
- The welder machine can be connected to the network only when the power socket is properly grounded.

7.4.1 Scheme of connection of 400V power plug connector (ProTIG 3000 DC)

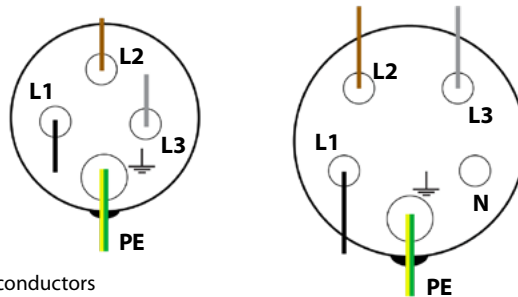

L1, L2, L3	Phase conductors
PE	Protective conductor
N	Neutral conductor



WARNING!

It is **forbidden** bridging PE and N cables. it may cause serious risk of electric shock!

In some cases, colours of power cords may vary from those shown on diagram. For example when the device has a four-wired three phase power cord. In this case, the PE protective conductor (yellow-green) must be connected to the terminal which is provided for it \perp . And the other cables must be connected to the appropriate terminals L1, L2, L3. If one of the wires colour is blue – do not connect it to the terminal N – neutral. In this case blue cable is one of the phase conductors L1, L2, L3.

7.5 INSTALLATION – TIG WELDING



Before connecting hardware and shielding gas to the device, make sure that the device is disconnected from power source and switch **8** is in the OFF position.

7.5.1 Cooler installation

1. Connect the control cable to the cooler sockets **13**.
2. Connect the control cable to the sockets in TIG equipment **1**.
3. Unscrew the coolant cap **11**.
4. Pour coolant into the cooler (recommended by the manufacturer).
5. Screw the coolant cap.

7.5.2 Connecting the gas cylinder

1. The cylinder with appropriate shielding gas, should stand upright and be secured against tipping over in accordance with safety requirements.
2. Make sure that the valve cylinder is closed.
3. Connect properly gas regulator to cylinder valve.
4. Connect the gas hose into gas regulator outlet. Use special clamps to seal connection.
5. Connect gas hose to the device (4).



*The valve in the cylinder must be opened immediately before welding.
After welding it should be closed.*

7.5.3 TIG torch installation

1. Connect properly TIG torch plug into SK „-“ (2).
2. Connect properly TIG torch control plug into control socket (1).
Pay attention to suitable fitting of control pins.
3. Connect gas hose into shield gas connector at the front panel (4).
4. Liquid cooled TIG torches: connect the end of liquid hose (input) to coupler (12).
5. Liquid cooled TIG torches: connect the end of liquid hose (output) to coupler (10).

7.5.4 Connecting the device

1. Connect the cooler to the device (see 7.5.1).
2. Connect the gas pipe to the device (see 7.5.2).
3. Connect the welding holders TIG (see 7.5.3).
4. Connect the return line to the SK socket „+“ (3), and the mass clamp to the welded element.
5. Connect the welding device to the power source in accordance with the guidelines (see 7.4)
6. Turn on the device by setting switch (8) in the ON position.
7. The device is ready to work.

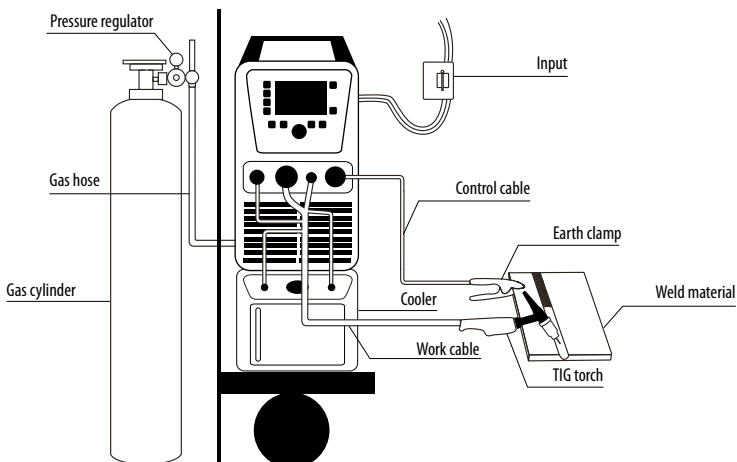

7.6 INSTALLATION – MMA WELDING



Before connecting hardware and shielding gas to the device, make sure that the device is disconnected from power source and switch **8** is in the OFF position.



The welding polarity depends on the type of electrodes used. Before connecting the cables refer to the requirements specified by the manufacturer of electrodes.

1. Connect electrode cable plug into SK socket **2** or **3**.
2. Connect return cable plug into appropriate SK socket **2** or **3**.
3. Connect earth clamp into workpiece.
4. Connect the welder into power supply in accordance with appropriate guidelines (see 7.4).
5. Turn on the welder by setting power switch **8** to the ON position.
6. The device is ready to weld.

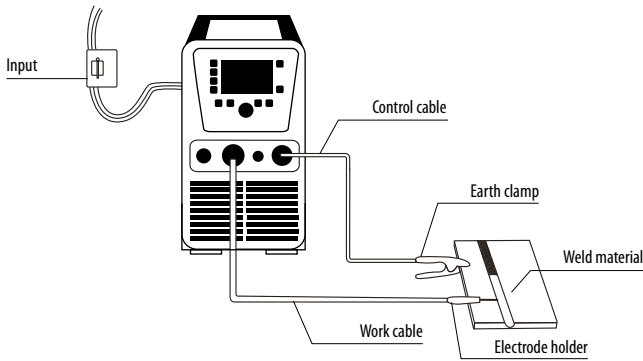

7.7 DEVICE CONTROL PANEL – USING

7.7.1 Function panel description

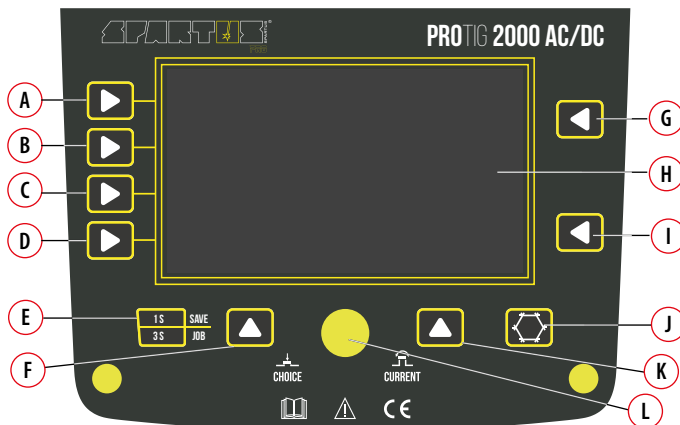

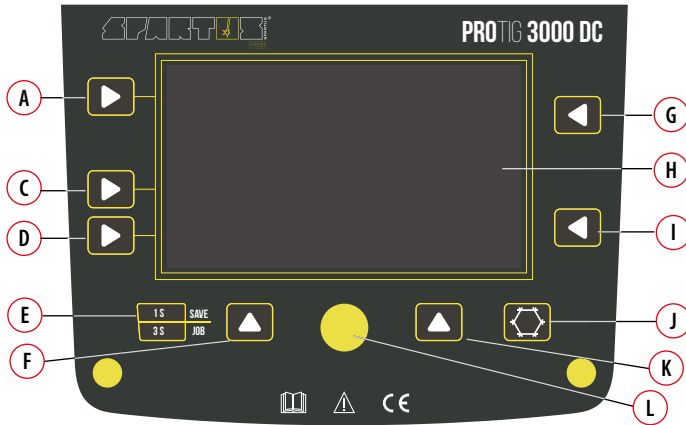

- | | | | |
|----------|--|----------|--|
| A | Welding mode key | G | Parameter 1 key: Hot Start/Balance / frequency |
| B | Output waveform key | H | LCD screen |
| C | Trigger mode selecting key 2T/4T | I | Parameter 2 key: Arc Force/electrode diameter |
| D | Welding function key: Pulse/No Pulse/ SingleSPOT/MultiSPOT | J | Cooling mode selecting key: gas/liquid |
| E | JOB key: save/recall mamory programs | K | Function 2 key |
| F | Function 1 key | L | Parameters select/adjust knob |

7.7.2 A detailed description of selected buttons on the panel

- B** OUTPUT WAVEFORM KEY
- **TIG DC / MMA DC** – Direct Current.
 - **TIG AC / MMA AC** (*square wave output AC*) – focuses arc for maximum penetration, fast travel speed with best directional control.
 - **TIG AC** (*sine wave output AC*) – traditional AC TIG welding wave form. It has quieter, „soft“ arc characteristic.
 - **TIG AC** (*triangle wave output AC*) – reduces heat input for same current setting. Be especially useful for welding thin metal.

F FUNCTION 1 KEY

Choice for the TIG method:

- **Pre Gas** – gas flow time before welding begins
- Initial current value
- **Up Slope** – welding current rise time

Choice for the SPOT welding mode:

- **Pre Gas** – gas flow time before welding begins

Choice for the JOB memory channels:

- activation of the saved memory channel

K FUNCTION 2 KEY

Choice for the TIG method:

- **Post Gas** – gas flow time after welding
- Final current value
- **Down Slope** – welding current decrease time

Choice for the SPOT welding mode:

- **Post Gas** – gas flow time after welding

Choice for the JOB memory channels:

- delete of the saved memory channel

L PARAMETERS SELECT/ADJUST KNOB

The TIG method:

- peak current value
- base current value
- pulse frequency
- pulse current width

The SPOT welding mode:

- welding current
- welding time
- welding break time (MultiSPOT)

Choice for the JOB memory channels:

- select a saved memory channel

PANEL DESCRIPTION DURING MMA WELDING

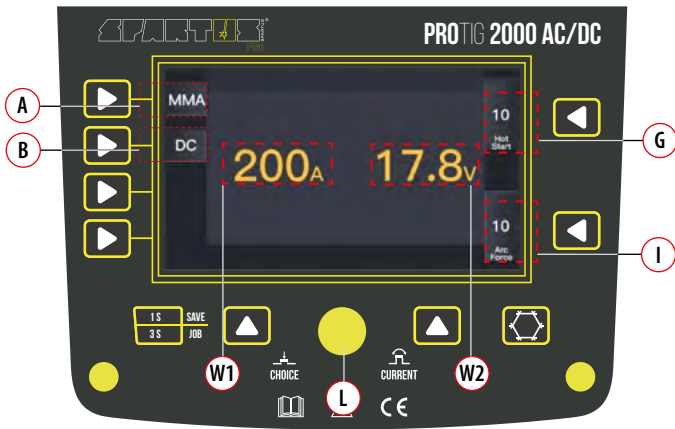

- A** WELDING MODE KEY – MMA
- B** OUTPUT WAVEFORM KEY– MMA DC / MMA AC
- G** HOT START – regulation range: 0 – 10
- I** ARC FORCE– regulation range: 0 – 10
- L** PARAMETERS ADJUST KNOB – regulation: welding current, Hot Start and Arc Force
- W1** WELDING CURRENT
- W2** WELDING VOLTAGE

PANEL DESCRIPTION DURING TIG HF/ TIG LIFT WELDING

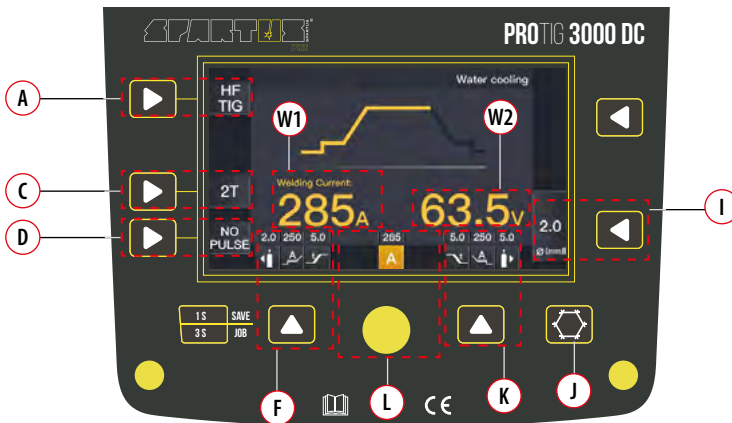
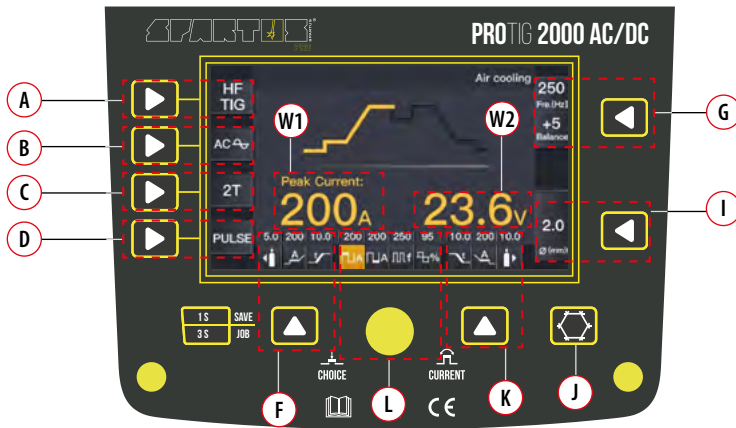

- A** WELDING MODE KEY TIG HF OR TIG Lift
- B** OUTPUT WAVEFORM KEY – TIG DC / TIG AC (AC waveform: sine, square, triangle)
- C** TRIGGER MODE SELECTING KEY 2T/4T
- D** WELDING FUNCTION KEY: PULSE/NO PULSE / SingleSPOT/MultiSPOT (*SPOT function is not available in Lift TIG welding*)
- G** TRIGGER MODE: AC FREQUENCY (regulation range: 50 – 250Hz) and BALANCE (regulation range: 10 – 99)
- I** TRIGGER MODE OF ELECTRODE DIAMETER
- F** Pre Gas, gas flow time before welding begins, Up Slope
- K** Post Gas, gas flow time after welding, Down Slope
- L** PARAMETERS SELECT/ADJUST KNOB (see 7.7.2)
- W1** WELDING CURRENT
- W2** WELDING VOLTAGE
- J** COOLING MODE SELECTING KEY: gas/liquid

PANEL DESCRIPTION DURING TIG PULSE WELDING

ProTIG 2000 AC/DC



(P1) PULSE PEAK CURRENT

(P2) PULSE BASE CURRENT

ProTIG 3000 DC



(P3) PULSE FREQUENCY: 0.5 – 999Hz

(P4) PULSE WIDTH: 5 – 95%

PANEL DESCRIPTION DURING TIG SPOT WELDING: SINGLE SPOT and MULTI SPOT

ProTIG 2000 AC/DC

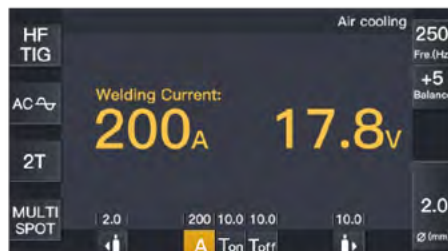

ProTIG 3000 DC



(S1) WELDING CURRENT

(S2) WELDING TIME: 0.2 – 1.0s

(S3) WELDING BREAK TIME: off – 10.0s

JOB PROGRAM PANEL DESCRIPTION

ProTIG 2000 AC/DC



J1 WELDING MODES

Display of selected welding functions.

J2 PARAMETERS

All selected parameter values.

J3 PROGRAM NUMBER

You can save 10 programs with selected parameters using the JOB button.

J4 ACTIVATION OF MEMORY CHANNEL

J5 DELETE OF MEMORY CHANNEL

ProTIG 3000 DC



7.7.3 Save / activate / delete memory channels on the device

The device has 10 memory channels on which you can save the most-used machine settings. After selecting the appropriate parameters, press the button **E** for 1s (see 7.7.1). The settings will be saved to the first free channel.

Calling up saved memory channels consists of holding the button for 3s **E** (see 7.7.1). The memory channel number is selected by turning the knob **L**. The memory channel is activated by pressing the button **J4**. The saved memory channel is deleted with the button **J5**.

7.7.4 Course of TIG welding process (2T)

During TIG function 2T, you can not set the current parameters of the initial and final current.

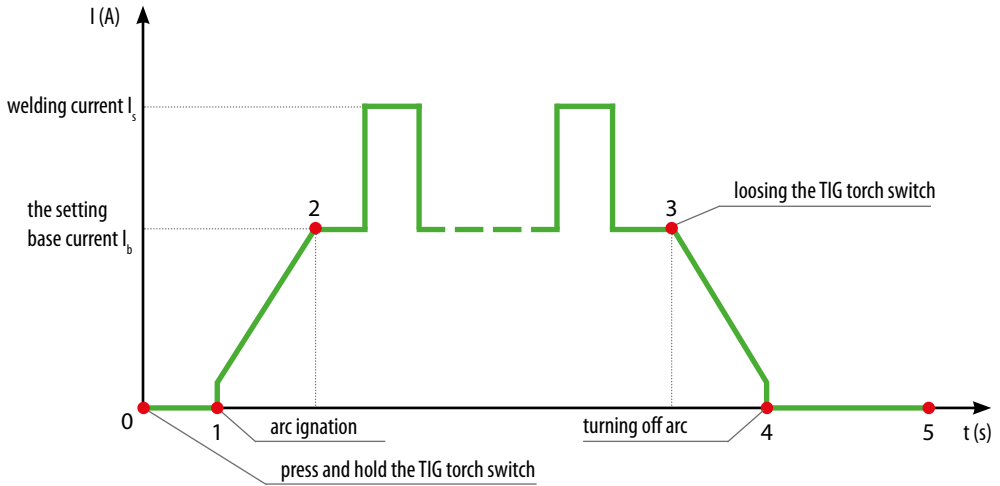

- 0 Press the gun switch and hold it. Electromagnetic gas valve is turned on. The shielding gas starts to flow.
- 0-1 Pre-gas time.
 - 1 Initiation of the welding arc.
- 1-2 Arc is ignited and the output current rises to the setting welding current from the min. welding current.
- 2-3 During the whole welding process, the gun switch is pressed and held without releasing.
 - 3 Release the gun switch, the welding current will drop in accordance with the selected down-slope time.
- 3-4 The current drops to the minimum welding current from the setting current, and then arc is turned off.
- 4 Termination arc welding.
- 4-5 Post-gas time, after the arc is turned off. You can adjust it (0.1~10s) through turning the knob on the front panel.
- 5 Electromagnetic valve is closed and stop argon flowing. Welding is finished.

7.7.5 Course of TIG welding process (4T)

During TIG 4T, it is possible to preset the current value of the initial and final current. With this feature, you can prevent flooding at the beginning of the weld and fill the crater formed at the end of the weld.

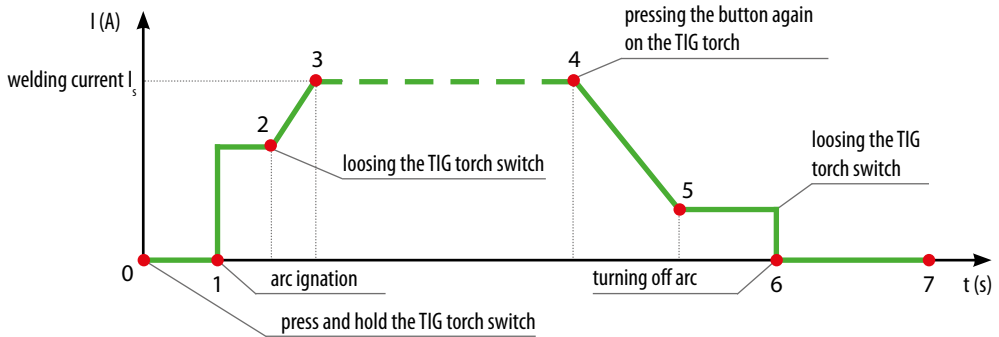

- 0 Press and hold the gun switch, Electromagnetic gas valve is turned on. The shielding gas starts to flow.
- 0-1 Pre-gas time.
- 1-2 Arc is ignited at t_1 and then output the setting value of start current.
- 2 Loosen the gun switch, the output current slopes up from the start current.
- 2-3 The output current rises to the setting value, the upslope time can be adjusted.
- 3-4 Welding process. During this period, the gun switch is loosen.
- 4 Press the torch switch again, the welding current will drop in accordance with the selected down-slope time.
- 4-5 The output current slopes down to the crater current. The downslope time can be adjusted.
- 5-6 The crater current time.
- 6 Loosen the gun switch, stop arc and keep on argon flowing.
- 6-7 Post-gas time.
- 7 Electromagnetic valve is closed and stop argon flowing. Welding is finished.

7.8 WIRELESS REMOTE CONTROL CONFIGURATION

The welding machines can be configured to communicate exclusively with wireless foot pedal or remote control panel. This is done by a simple process of synchronising the wireless remote control and the machine frequencies. Each interface frequency assigned is unique, so it is possible to use several wireless control systems/machines in the same area with no problems. The direct range of the wireless control system is approximately 10m, this will be affected by the physical location of the machine and the remote control.

7.8.1 Connection to the machine

1. Turn on Handy Center wireless remote control.
2. Press COMMAND (F) and then Connect (M). Remote control will connect to the first free canal in the machine.
3. Turn on the power switch of the corresponding welding machine to connect and control the machine.

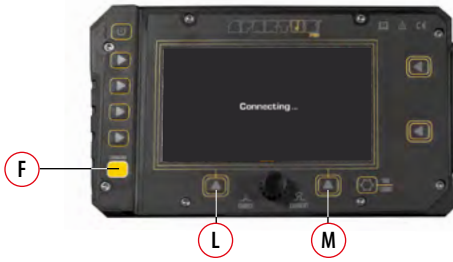

4. To connect remote control with second device, press the button COMMAND **F** again, then with the knob **L** select the next free channel and press Connect **M**.
5. Turn on the power switch of the second welding machine to connect and control the machine.

7.8.2 To remove the control function of remote control box on welding machine

To disconnect the remote control, select the appropriate connection channel with the device, and then press Disconnect on the remote control.

! When connecting the equipment to the machine, please ensure, that the distance between the remote control and the machine does not exceed 10m. If the connection window does not appear automatically after 20s, it means, the machine is not connected to the device. At this point, place the device near the machine and try again. If it is still not available, please seek help from maintenance personnel.



7.9 PEDAL SWITCH CONTROL

1. When plug the twelve-lead aero-socket of pedal switch in it. Welder will identify the pedal switch, the welding current knob on the front panel will can't use and only 2T can be selected.
2. When use the adjustment knob of max-welding current beside the pedal, can set the max-current you want.



8. MAINTENANCE

! **WARNING!** Before performing any maintenance or repairing of device, disconnect welding machine from the power source and wait at least 5 minutes. The voltage accumulated in capacitors should be discharged at this time to a safe level. But even after that operation you should be careful.

i Make sure that the device is disconnected from the power source, and switch **8** is in the OFF position, before connecting accessories and shielding gas to the device. Maintenance and repair work may be performed only by qualified personnel with the appropriate permissions. Regular maintenance provides adequate service life and trouble-free operation of the device.

Routine maintenance (daily: before use/installation):

- Perform a visual inspection of the housing, knobs, control panel.
- Inspect (visual inspection) the power cord and power plug. Check the insulation of the cable.
- Check the condition of welding cables and their connectors. If cable insulation is damaged – replace it. If connection is too loose – eliminate backlash.
- Check if cooling fan is working properly.
- Make sure that all vents are not obstructed.

At least once a month:

- Regularly remove dust from inside of the machine. Use for this compressed air. The pressure should be sufficiently low so as not to damage small components inside the machine. If in the workplace, dust levels are high. You should clean machine often.
- Perform inspection of connection of internal electrical components. If anywhere the joints are loose, tighten them.

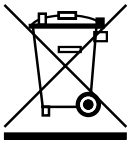
9. ENVIRONMENTAL PROTECTION

The product must not be disposed of into an ordinary waste container. It is totally forbidden to dispose of electric or electronic equipment marked with a crossed-out trash can symbol by throwing it into ordinary waste containers. According to the WEEE directive (directive 2012/19/UE), binding within the European Union, such products should be disposed of according to local regulations.

We hereby inform the client that, according to the regulations, each commodity is burdened with waste disposal costs (WDC) according to charging rates valid for a given year.

Attention! If using liquid to water-cooled torches, utilize it according to attached information.

10. TROUBLESHOOTING

Not all problems with functioning of the device, are the evidence of failure. You can independently carry out an analysis in search of probable failure. In case of doubt, please contact to SPARTUS® dealer or authorized service center.



During the warranty period all repairs should be carried by authorized service center. Repairs carried out by unauthorized persons will void the warranty.

PROBLEM WITH TURNING ON THE MACHINE

	Incorrectly connected power. Switching on voltage control system.
After turning on the unit the fan is not working, digital meter is working. The unit does not weld.	Unstable supply voltage. Too thin power cords or incorrectly connected power cables.
	Incorrectly turned on power switch. Switching on control system overvoltage.
	Luźne połączenia na włączniku ON/OFF.
After turning ON the switch the device does not correspond	Poorly connected to the supply voltage.
	Failure of power switch

<i>TIG WELDING PROBLEMS</i>	
The problem with TIG arc ignition (HF and no HF). There is a spark when HF works.	Poorly connected TIG torch. Return cable poorly connected or not connected. Damaged current cable of TIG torch.
The problem with TIG arc ignition (HF and no HF). There is no spark when HF works.	Damaged microswitch. Control plug is not connected. Problems with control plug.
The problem with TIG arc ignition (strikes only by friction). There is no spark when HF works.	HF board is broken. Device is damaged
No gas flow.	Closed valve in the gas cylinder, a closed valve in the gas pressure regulator. Clogged gas hoses leading the gas to the device. Electromagnetic valve is damaged.
After switching on the device gas flows all the time.	Electromagnetic valve is damaged.
The problem of obtaining adequate weld penetration.	Too low welding current.
Poor quality of weld.	Improper welding parameters Too little flow of the shielding gas or its quality is inadequate. Excessively worn of tungsten electrode
<i>MMA WELDING PROBLEMS</i>	
Arc ignition problem.	Incorrect connection of return cable or there is no connection of return cable. Too low welding current.
Excessive spatter welding. The problem with the arc ignition.	Incorrect welding polarity.
Unstable arc, excessive spatter welding, poor weld quality – MMA.	Incorrect welding polarity. Electrode is damp or incorrectly heated Unstable voltage in
No load voltage equals 0V	Damaged device
<i>OTHERS</i>	
The warning light came on. The overheating protection was switched on.	Too much welding current. Exceeded operation cycle.
The warning light on the functional front panel came on	Voltage too high in the mains. Too much power voltage drop Too many devices connected at one time to the network.

Notes

Notes



SUBSCRIBE

Subskrybuj kanał SPARTUS.INFO

Subscribe to the channel
SPARTUS.INFO

